

FAIRADISE



2017 BERRIEN COUNTY YOUTH FAIR

Sr. Patterns

Berrien County Youth Fair

Showmanship - Saddle Seat - 1045, 1046 (Sr. Exhibitor)

Show Date: 2017

www.HorseShowPatterns.com

www.HorseShowPatterns.com

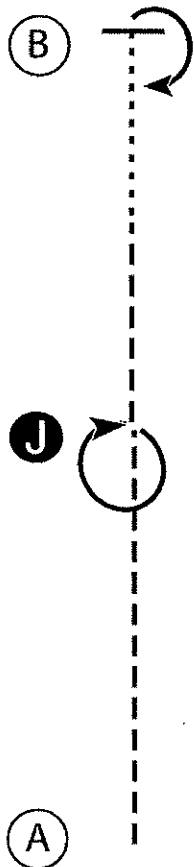

1. Trot from A to Judge.
2. Stop, perform a 360 degree turn and set up for inspection.
3. When dismissed trot half way to B, break to the walk and walk to B.
4. Stop at B, perform a 180 degree turn, and wait for instructions from the ring steward.

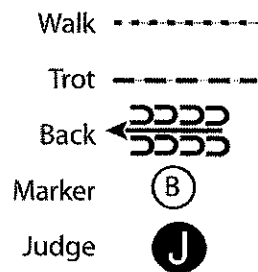

[S/1-9]

Pattern Provided by:

BCYF Equine Committee

Berrien County Youth Fair

Showmanship - Hunt Type - 1047, 1048 (Sr. Exhibitor)

Show Date: 2017

www.HorseShowPatterns.com

www.HorseShowPatterns.com

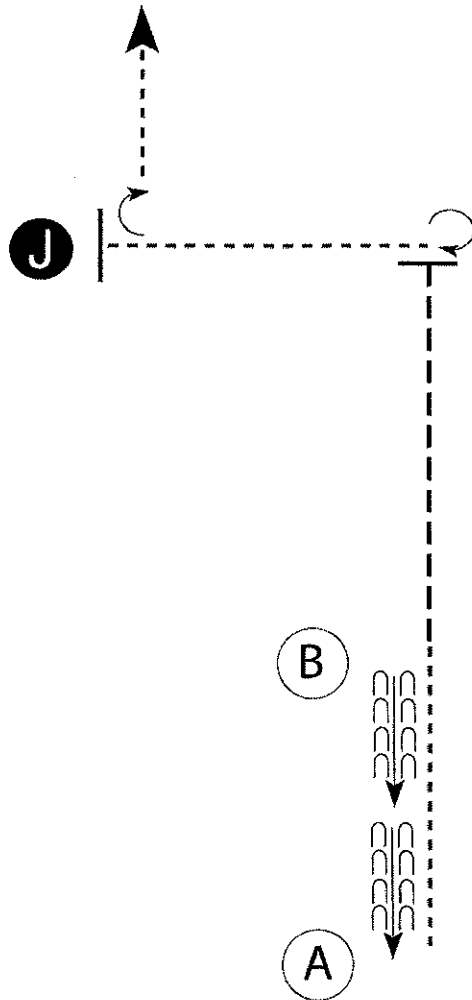

Be ready at B.

1. When acknowledged, back to A.
2. Walk to B.
3. Trot until even with judge and stop.
4. Perform a 270 degree turn.
5. Walk to judge, stop and set up for inspection.
6. When dismissed, perform a 90 degree turn.
7. Walk straight away from judge.

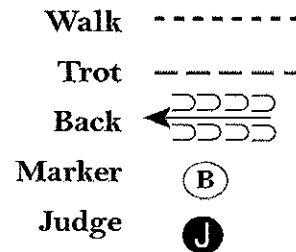

Follow the instructions of your ring steward.

[S/2-65]

Pattern Provided by:

BCYF Equine Committee

Berrien County Youth Fair

Showmanship - Western 1049, 1050, 1051 (Sr. Exhibitor)

Show Date: 2017

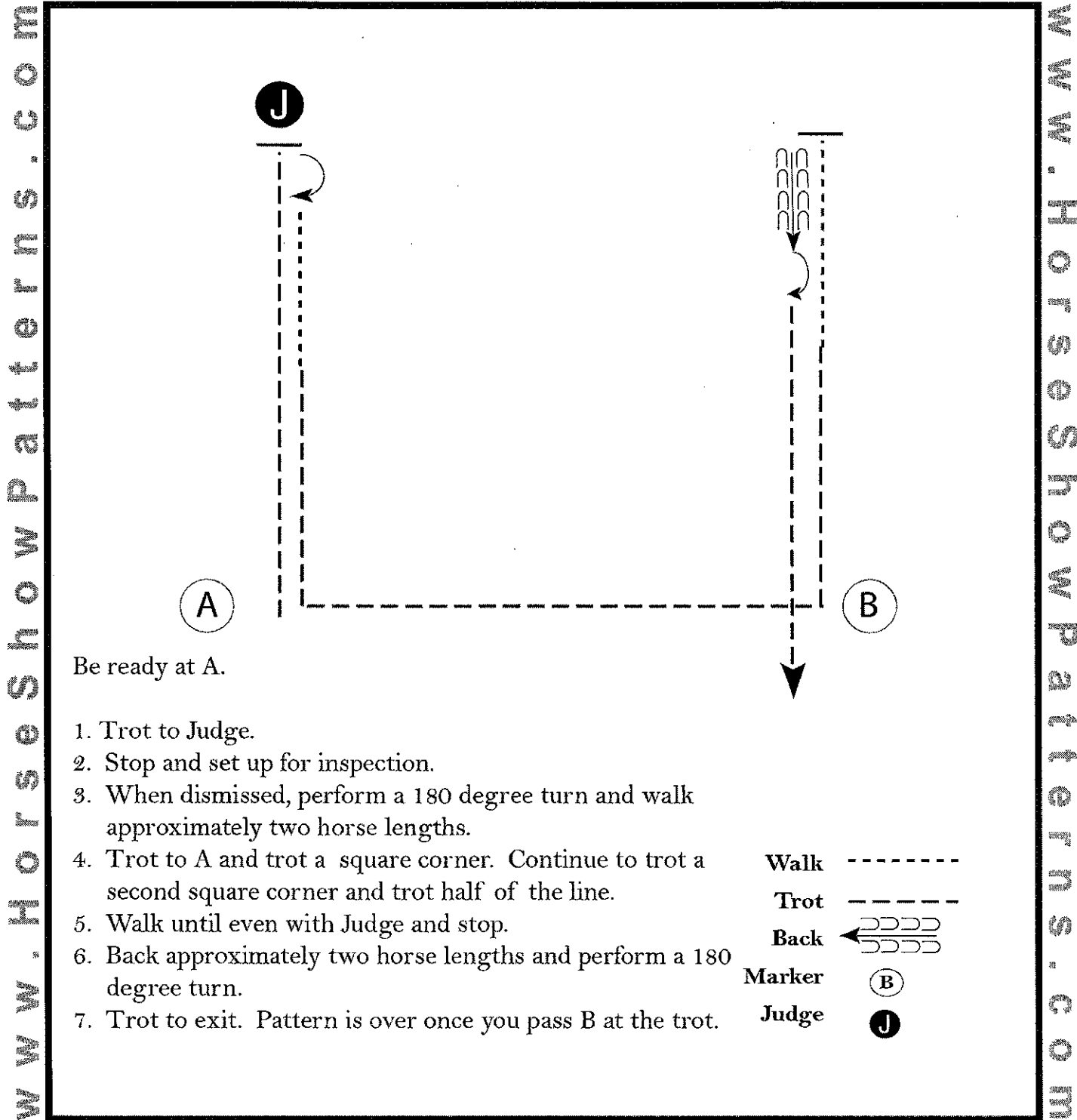

Be ready at A.

1. Trot to Judge.
2. Stop and set up for inspection.
3. When dismissed, perform a 180 degree turn and walk approximately two horse lengths.
4. Trot to A and trot a square corner. Continue to trot a second square corner and trot half of the line.
5. Walk until even with Judge and stop.
6. Back approximately two horse lengths and perform a 180 degree turn.
7. Trot to exit. Pattern is over once you pass B at the trot.

Walk -----
 Trot -----
 Back ←-----
 Marker (B)
 Judge (J)

[S/2-109]

Pattern Provided by:
BCYF Equine Committee

Berrien County Youth Fair

Showmanship - Gymkhana/Novice - 1052, 1053, 1054 (Sr. Exhibitor)

Show Date: 2017

W W W . H O R S E S H O W P A T T E R N S . C O M

W W W . H O R S E S H O W P A T T E R N S . C O M

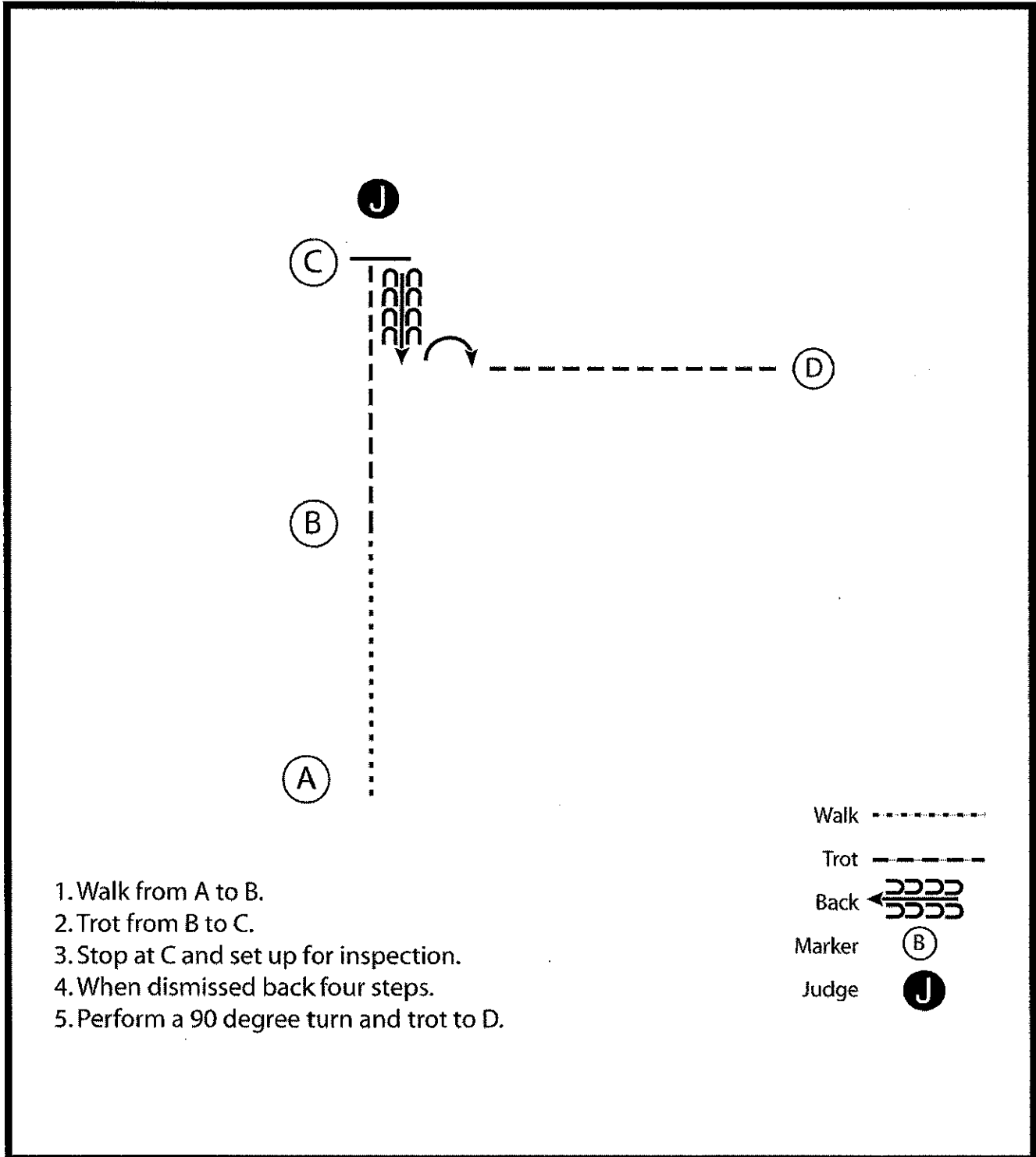

[S/2-7]

Pattern Provided by:

BCYF Equine Committee

Berrien County Youth Fair

Western Riding - 1083 (Jr. & Sr. Exhibitors)

Show Date: 2017

W W W . H O R S E S H O W P A T T E R N S . C O M

W W W . H O R S E S H O W P A T T E R N S . C O M

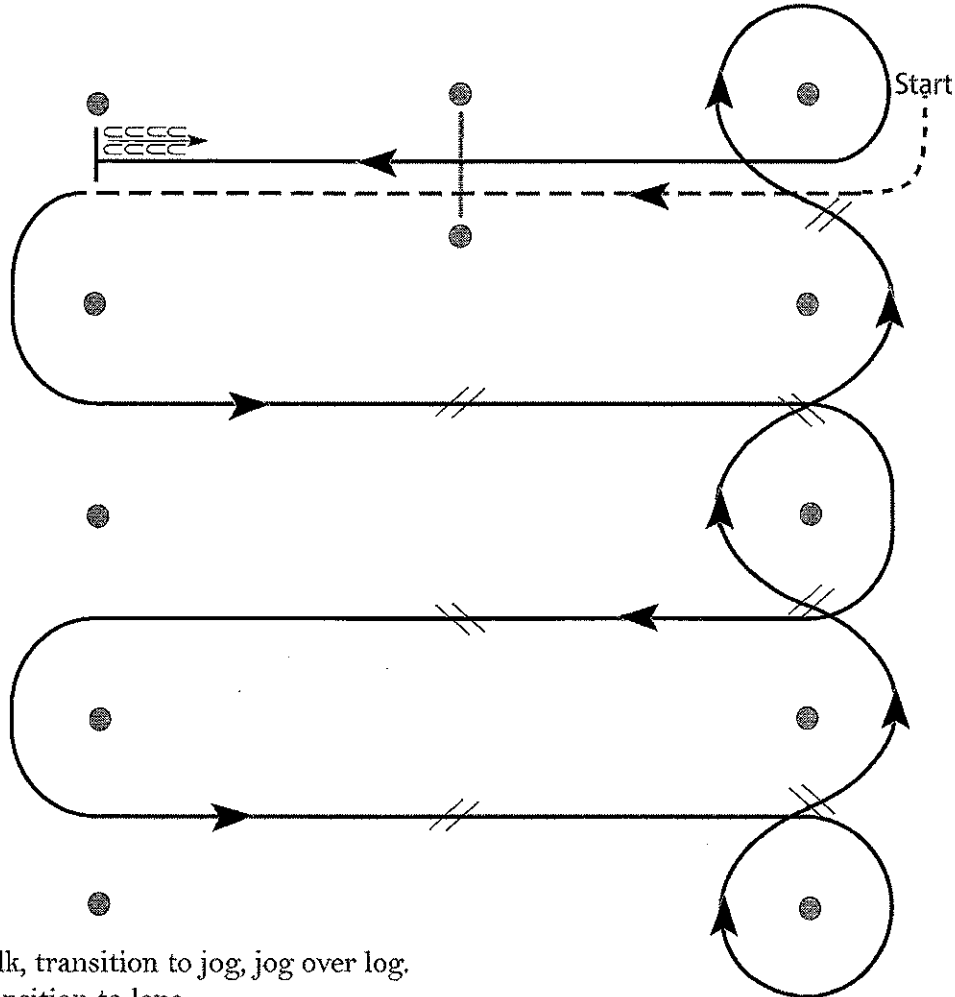

1. Walk, transition to jog, jog over log.
2. Transition to lope.
3. First crossing change.
4. Second crossing change.
5. Third crossing change.
6. Circle and first line change.
7. Second line change.
8. Third line change.
9. Fourth line change and circle.
10. Lope log.
11. Lope, stop and back.

[WR/OP-2]

Pattern Provided by:

BCYF Equine Committee

Berrien County Youth Fair

Ranch Riding - 1086 (Jr. & Sr. Exhibitors)

Show Date: 2017

www.HorseShowPatterns.com

www.HorseShowPatterns.com

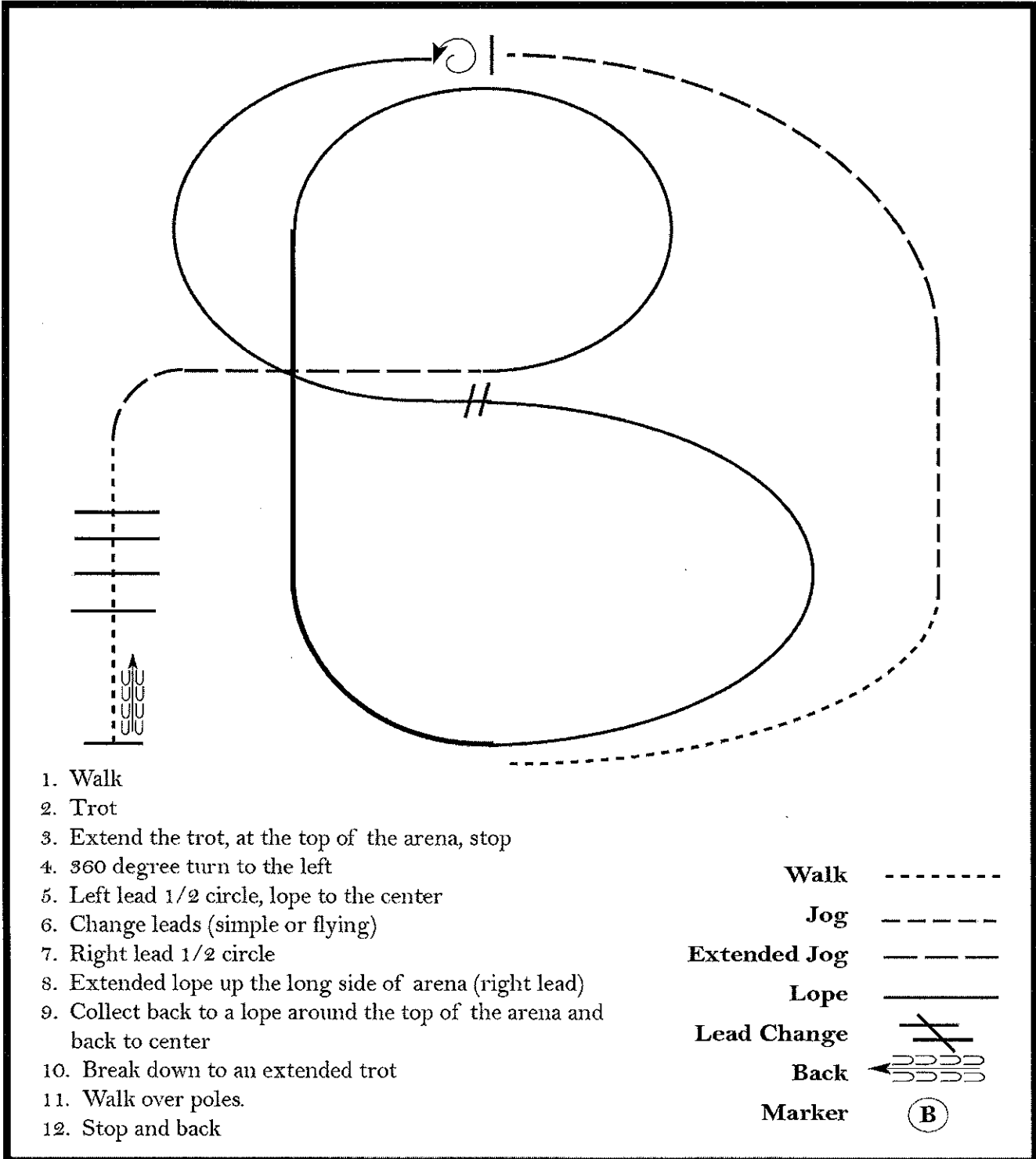

1. Walk
2. Trot
3. Extend the trot, at the top of the arena, stop
4. 360 degree turn to the left
5. Left lead 1/2 circle, lope to the center
6. Change leads (simple or flying)
7. Right lead 1/2 circle
8. Extended lope up the long side of arena (right lead)
9. Collect back to a lope around the top of the arena and back to center
10. Break down to an extended trot
11. Walk over poles.
12. Stop and back

- Walk
- Jog
- Extended Jog
- Lope
- Lead Change
- Back
- Marker

[RR/1]

Pattern Provided by:

BCYF Equine Committee

Berrien County Youth Fair

Ranch Trail - 1087 (Jr. & Sr. Exhibitors)

Show Date: 2017

www.HorseShowPatterns.com

www.HorseShowPatterns.com

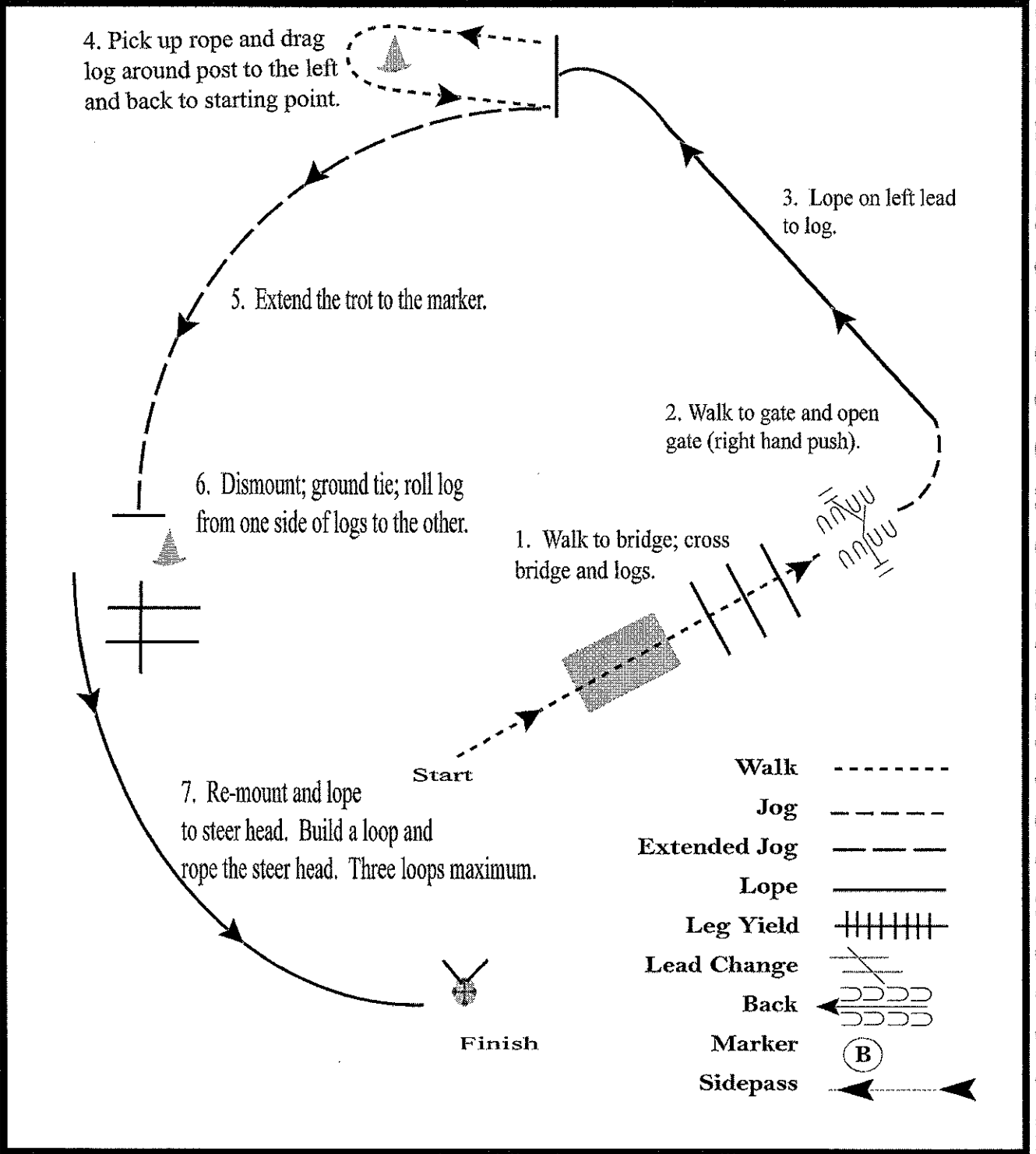

[RT/4]

Pattern Provided by:

BCYF Equine Committee

Berrien County Youth Fair

Saddle Seat Equitation - 1090, 1091 (Sr. Exhibitor)

Show Date: 2017

www.horsheshowpatterns.com

www.horsheshowpatterns.com

Begin at the in gate.

1. Canter the first half circle on the left lead.
2. Canter the second half circle on the right lead.
3. Stop briefly in the center of the arena.
4. Trot the third half circle on the right diagonal.
5. Trot the fourth half circle on the left diagonal. Stop briefly (B).
6. Canter in a clockwise direction along the rail and around curve (C).
7. Go directly into the trot on the left diagonal and continue to the end of the straightaway (D) showing two changes of diagonal.
8. Continue the trot around the curve and to the midpoint of the straightaway (A).

The workout has been completed - Thank You.

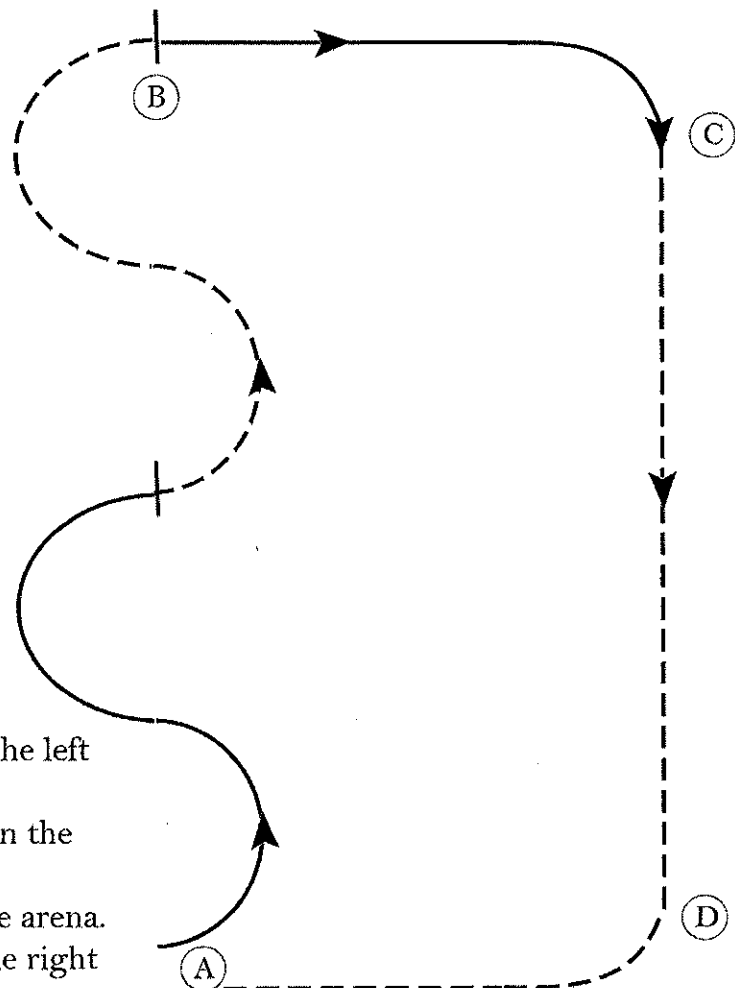

- Walk - - - - -
- Trot
- Extended Trot - - - - -
- Canter _____
- Lead Change
- Back
- Reference Point (B)

[SSE/17]

Pattern Provided by:

BCYF Equine Committee

Berrien County Youth Fair

Hunt Seat Equitation - 1094, 1095, 1096 (Sr. Exhibitor)

Show Date: 2017

www.HorseShowPatterns.com

www.HorseShowPatterns.com

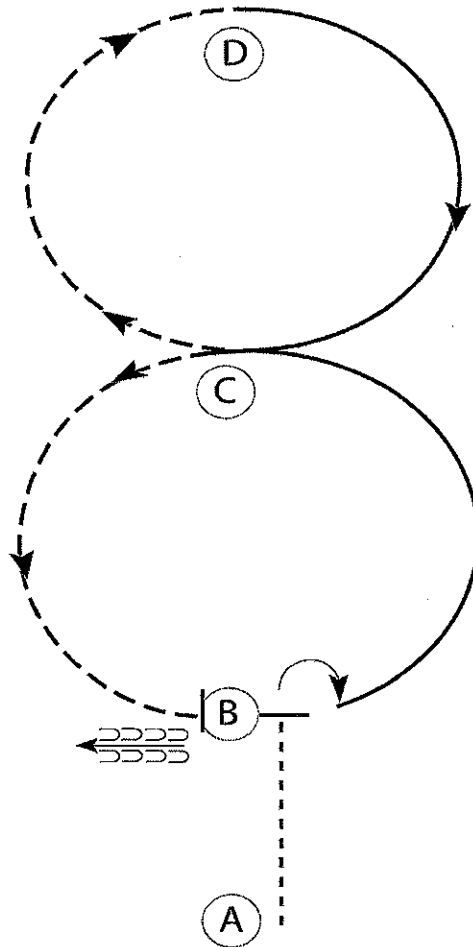

Be ready at A.

1. Walk to B.
2. Stop at B and perform a 90 degree turn to the right on the forehand.
3. Canter on the left lead to C.
4. Posting trot from C to D.
5. Canter on the right lead from D to C.
6. Posting trot from C to B.
7. Stop at B and back one horse length.

Follow the instructions of your ring steward.

Walk	-----
Trot	-----
Extended Trot	-----
Canter	-----
Leg Yield	
Lead Change	↗ ↘
Back	←←←←
Marker	Ⓚ
Sidepass	←→
Hand Gallop	-----

[HSE/2-13]

Pattern Provided by:

BCYF Equine Committee

Berrien County Youth Fair

English Equitation - Walk Trot - 1097 (Sr. Exhibitor)

Show Date: 2017

W W W . H O R S E S H O W P A T T E R N S . C O M

W W W . H O R S E S H O W P A T T E R N S . C O M

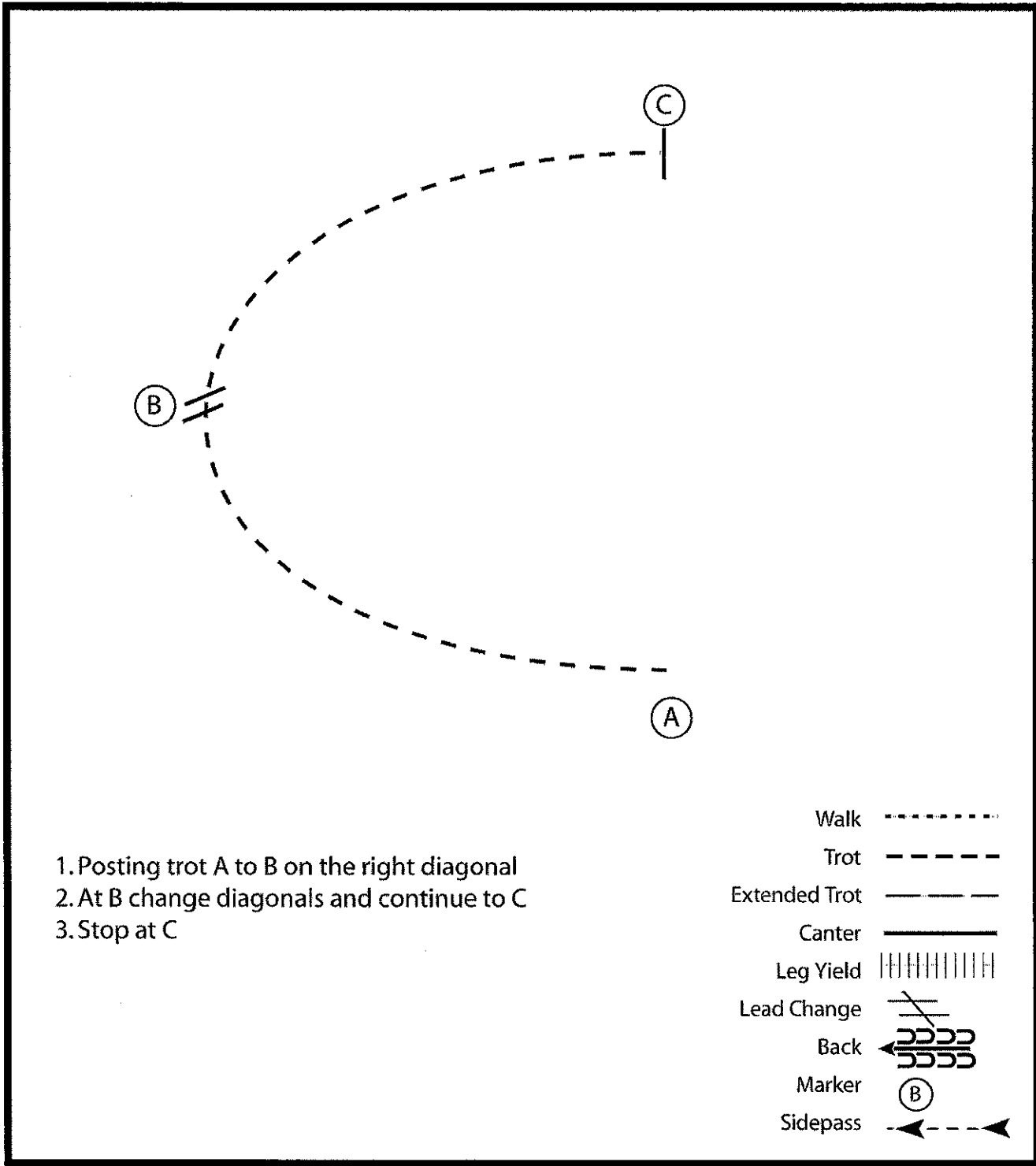

[HSE/WT-9]

Pattern Provided by:

BCYF Equine Committee

Berrien County Youth Fair

Horsemanship - 1176, 1177, 1178 (Sr. Exhibitor)

Show Date: 2017

www.horsheshowpatterns.com

www.horsheshowpatterns.com

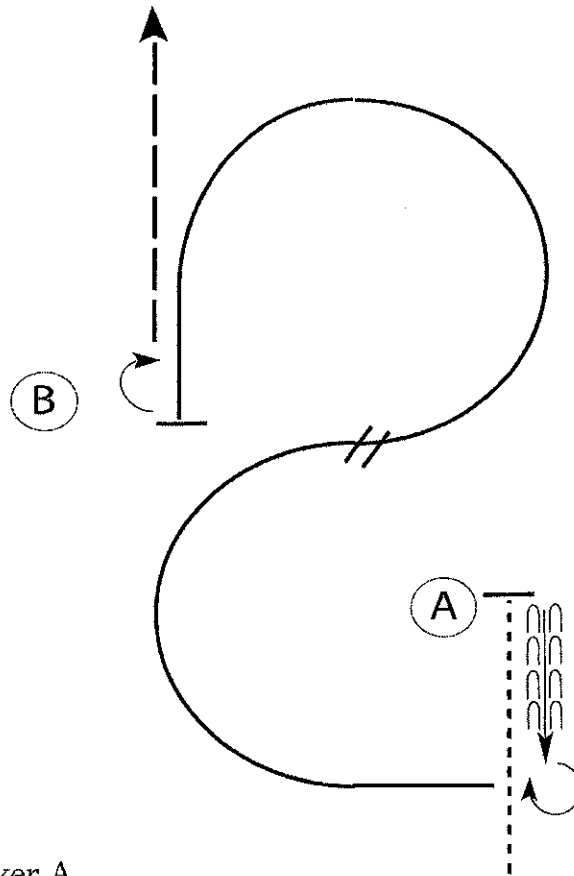

Be ready before marker A.

1. Walk to A.
2. Stop and back approximately one horse length.
3. Execute a 3/4 turn to the right and lope on the right lead.
4. Perform a lead change and lope on the left lead to B.
5. Stop at B and execute a 1/2 turn to the right.
6. Jog to exit.

Follow the instructions of your ring steward.

Walk	-----
Jog	-----
Extended Jog	-----
Lope	—————
Leg Yield	
Lead Change	⋈
Back	←←←←←
Marker	⊙
Sidepass	←-----←

[WH/2-68]

Pattern Provided by:
BCYF Equine Committee

Berrien County Youth Fair

Horsemanship - WalkTrot - 1179 (Sr. Exhibitor)

Show Date: 2017

www.HorseShowPatterns.com

www.HorseShowPatterns.com

Be ready at A.

1. Walk to middle of pattern.
2. Jog in an arc to the middle of your pattern.
3. Stop and back.

Walk
Jog	-----
Extended Jog	- - - - -
Lope	—————
Lead Change	///
Back	←———
Marker	ⓑ

[WH/WT-112]

Pattern Provided by:
BCYF Equine Committee

Berrien County Youth Fair

In-Hand Jumping Mini/Pony - 1222 (Jr. & Sr. Exhibitors)

Show Date: 2017

www.HorseShowPatterns.com

www.HorseShowPatterns.com

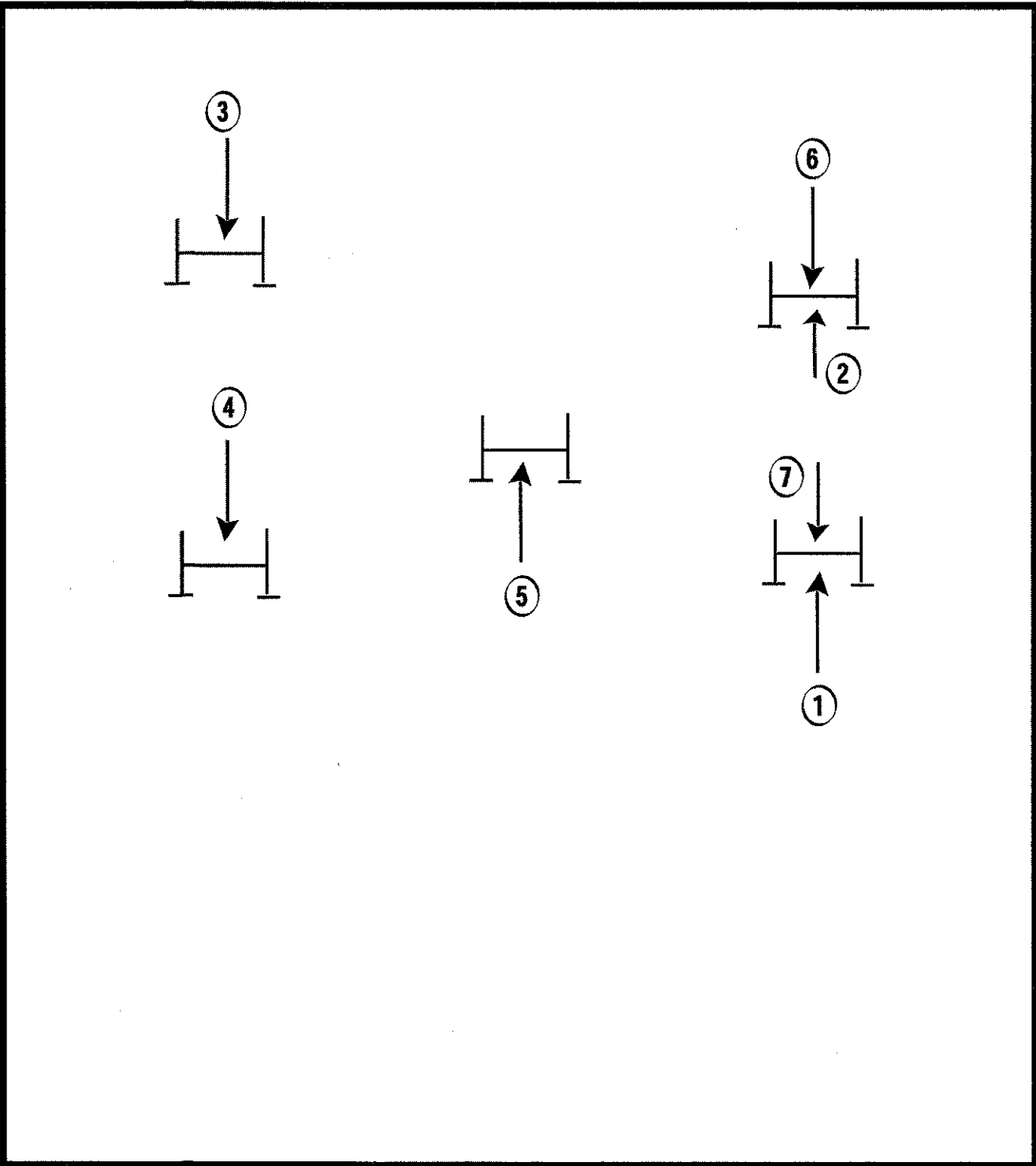

[MHP/H-6]

Pattern Provided by:
BCYF Equine Committee

Berrien County Youth Fair

Reining - 1224 (Sr. Exhibitor)

Show Date: 2017

www.HorseShowPatterns.com

www.HorseShowPatterns.com

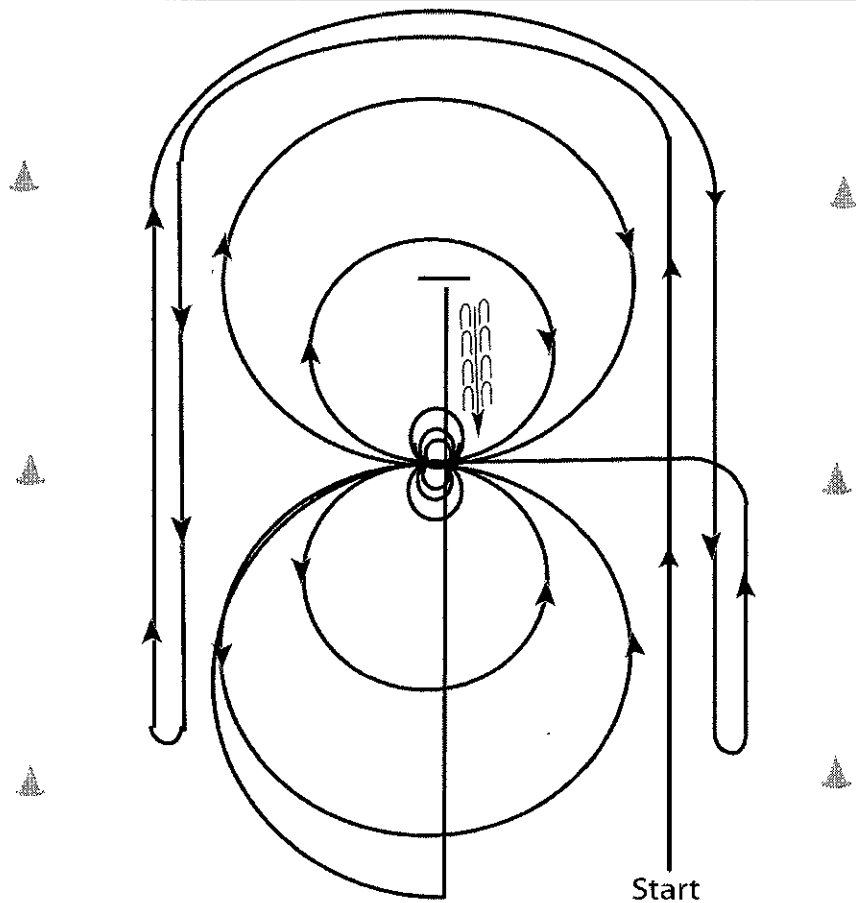

1. Beginning, lope straight up the right side of the arena, circle the top of the arena, run straight down the opposite or left side of the arena past the center mark and do a right rollback - no hesitation.
2. Continue straight up the left side of the arena circle back around the top of the arena run straight down the right side of the arena past the center marker and do a left rollback - no hesitation.
3. Continue up the right side of the arena to the center marker, at the center marker horse should be on the left lead and complete two circles to the left, one large fast and one small slow. Stop at center. Hesitate.
4. Complete three spins to the left. Hesitate.
5. Complete two circles to the right, one large fast and one small slow. Stop at center. Hesitate.
6. Complete three spins to the right. Hesitate.
7. Begin a large fast circle to the left, do not close this circle. Continue up the center of the arena past the center marker and do a sliding stop.
8. Back up at least ten feet. Hesitate to demonstrate completion of pattern.

[R/NRHAP-13]

Pattern Provided by:

BCYF Equine Committee

Berrien County Youth Fair

In Hand Trail - 1234, 1232 (Sr. Exhibitor)

Show Date: 2017

www.HorseShowPatterns.com

www.HorseShowPatterns.com

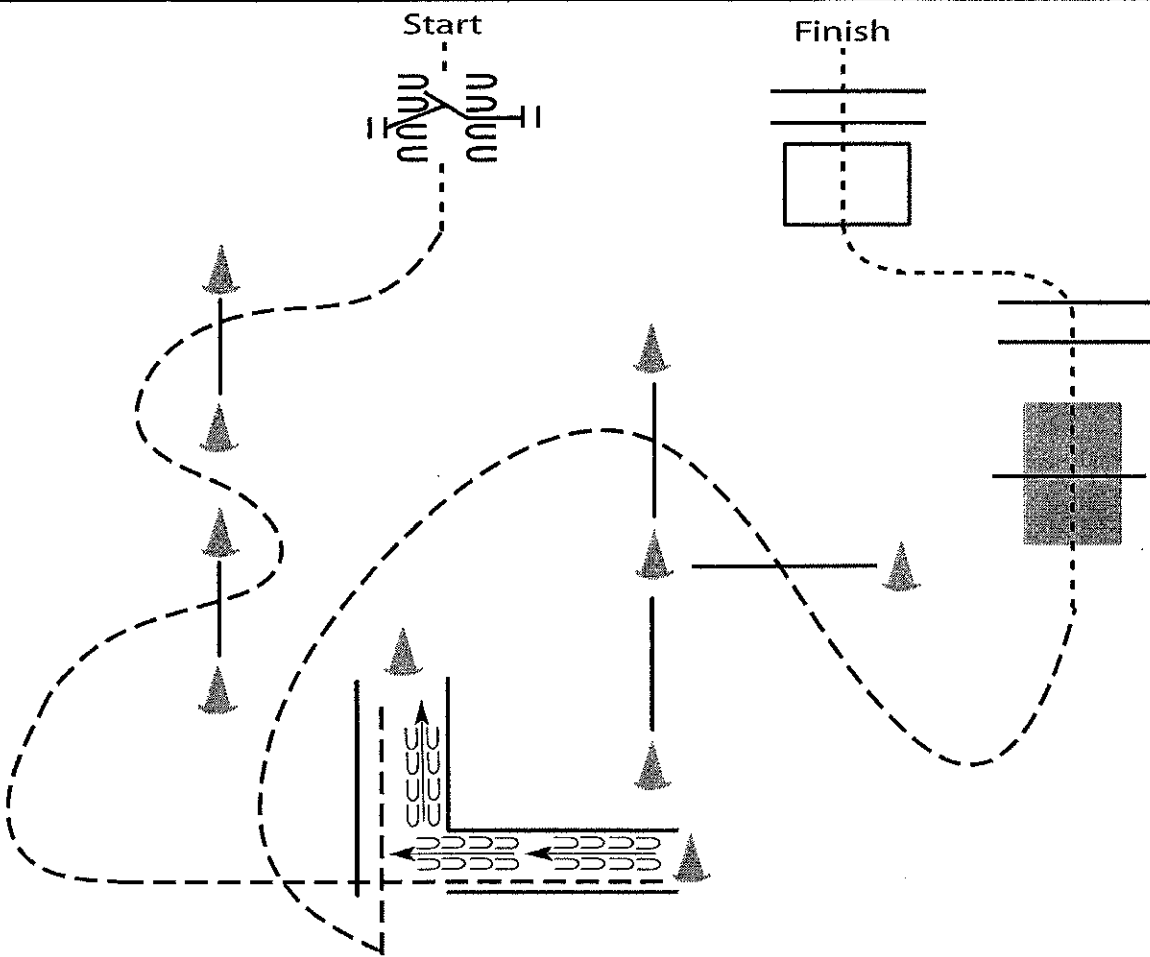

1. Walk to and work gate with left hand .
2. Jog through cones, over poles and into chute.
3. Back the L.
4. Jog out of chute, over poles and to bridge.
5. Walk over bridge and poles to box.
6. Walk through box and over elevated poles to finish.

Walk	-----
Jog	- - - - -
Extended Jog	-----
Lope	=====
Leg Yield	
Lead Change	—/—
Back	←←←←←
Marker	(B)
Sidepass	←-----→

[TWT-48]

Pattern Provided by:

BCYF Equine Committee

Berrien County Youth Fair

Trail - 1246, 1247, 1248 (Sr. Exhibitor)

Show Date: 2017

www.HorseShowPatterns.com

www.HorseShowPatterns.com

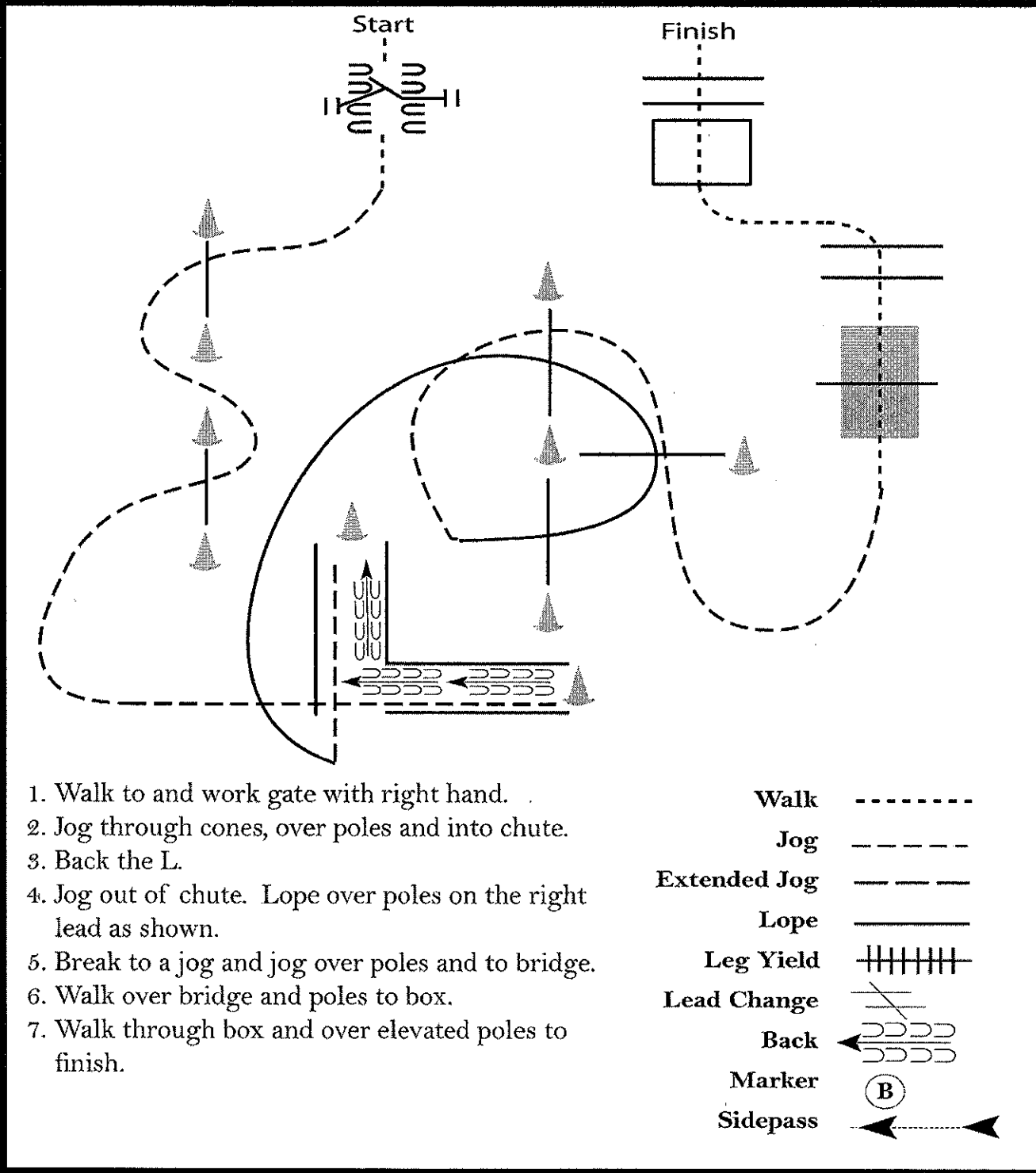

1. Walk to and work gate with right hand.
2. Jog through cones, over poles and into chute.
3. Back the L.
4. Jog out of chute. Lope over poles on the right lead as shown.
5. Break to a jog and jog over poles and to bridge.
6. Walk over bridge and poles to box.
7. Walk through box and over elevated poles to finish.

Walk	-----
Jog	- - - - -
Extended Jog	- - - - -
Lope	—————
Leg Yield	
Lead Change	///
Back	←←←←←
Marker	(B)
Sidepass	←-----←

[T/1-48]

Pattern Provided by:

BCYF Equine Committee